

Installation & Configuration Guidance of H8 ANPR Camera

Preface

(1) Product Portfolio:

IP Camera:

iDS-2CD7A26G0/P-IZHS (C)
 iDS-2CD7A46G0/P-IZHS (C)
 iDS-2CD7A26G0/P-IZHSY (C) --Support Wiegand
 iDS-2CD7A46G0/P-IZHSY (C) --Support Wiegand
 iDS-2CD7026G0/EP-IHSY(C)
 iDS-2CD7046G0/EP-IHSY(C)
 iDS-2CD8A46G0-XZ(H)S(Y)
 iDS-2CD8A86G0-XZ(H)S(Y)

DVR:

iDS-72XXHUHI-M/S

NVR:

DS-xxxxNI-I
 iDS-xxxxNXI-I

(2) Highlight Features:

- Newly support vehicle type, vehicle logo and plate characters recognition at the same time;
- Two detection modes can be selected:
 - a) Vehicle Priority: the overview of the vehicle needs to be obtained first, and then the plate recognition can be performed;
 - b) License Plate or Vehicle:

Product	Deeplearning Algorithm	Plate Recognition Mode	Recognition Object
DS-2CD7xxx/P	√	License Plate or Vehicle/Vehicle Priority	Plate characters
iDS-2CD7xxx/P	√	License Plate or Vehicle/Vehicle Priority	Plate characters, vehicle type
iDS-2CD7xxx/P (C)	√	License Plate or Vehicle/Vehicle Priority	Plate characters, vehicle type
iDS-2CD8Ax6G0	√	License Plate or Vehicle/Vehicle Priority	Plate characters, vehicle type

Chapter 1 Installation

- (1) It is recommended to cover no more than 2 lanes for each ANPR camera;
- (2) Select the appropriate lens according to following table:

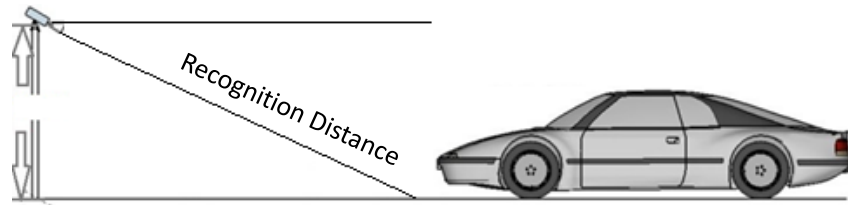

Model	Lens (mm)	Min recognition distance (m)	Max recognition distance (m)
iDS-2CD7XXX/P	2.8~12	2.5	13
	8~32	8	35
	3.8~16	3	19
	11~40	8	48
iDS-2CD8A46G0	8~32	8	35
iDS-2CD8A86G0	10~50	14	57

- (3) Choose installation height accordingly (**when pitch angle is 30°**):

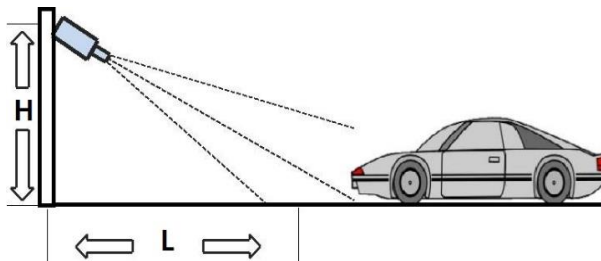

Type	Height(m)	Min L (m)
Entrance/Exit	1.5	2.5
	2	3.5
City Street	3	5
	4	7
	5	8.5
	6	10

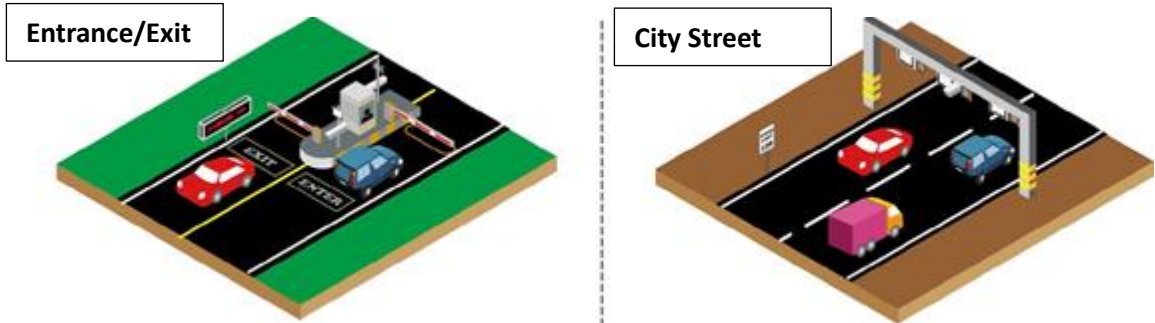

HIKVISION® Live View Playback Picture Application Configuration Smart Display VCA

VCA Resource
General VCA Settings
Road Traffic

Road Traffic

Detection Configuration Picture Advanced Parameters Configuration Blocklist & Allowlist

Type Vehicle Detection
 Enable

Area Settings Arming Schedule and Linkage Method

08-06-2021 Fri 16:02:24
Left border Lane line 1
Camera 01

Total Number of Lanes 1
Region Europe Region
Country/Region General

Select Mode Entrance/Exit
City Street
Alarm input

Remove Duplicated License Plates
Time Interval 4 minute(s)

Save

(4) The pitch angle (the angle between camera-vehicle line and the road) should

be larger than 15° and less than 30°

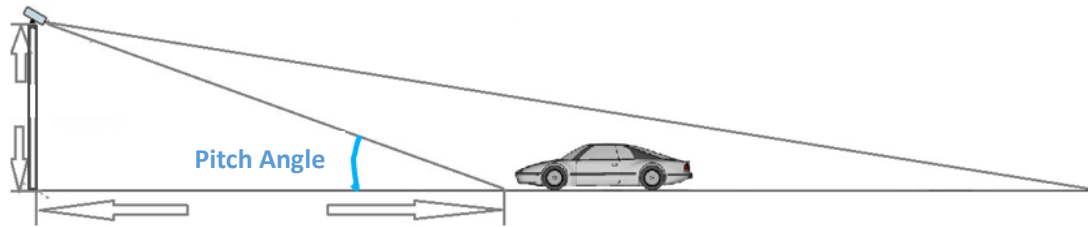

Example:

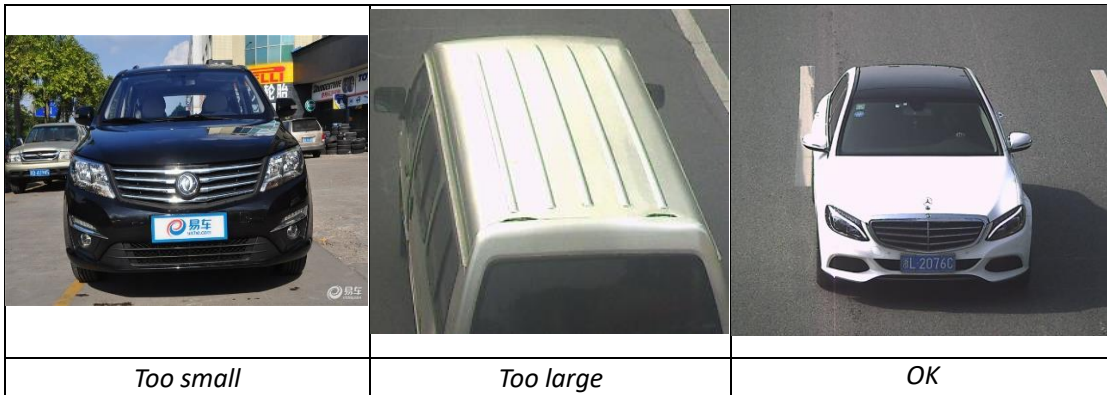

(5) The angle between the vehicle-moving direction and the vertical direction should be less than 30°

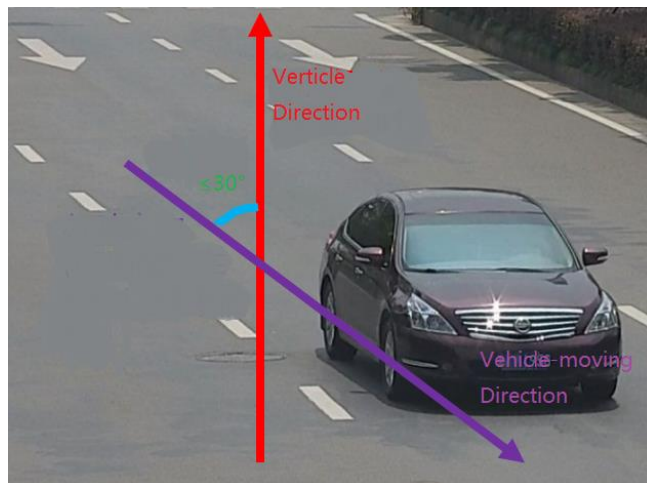

Example:

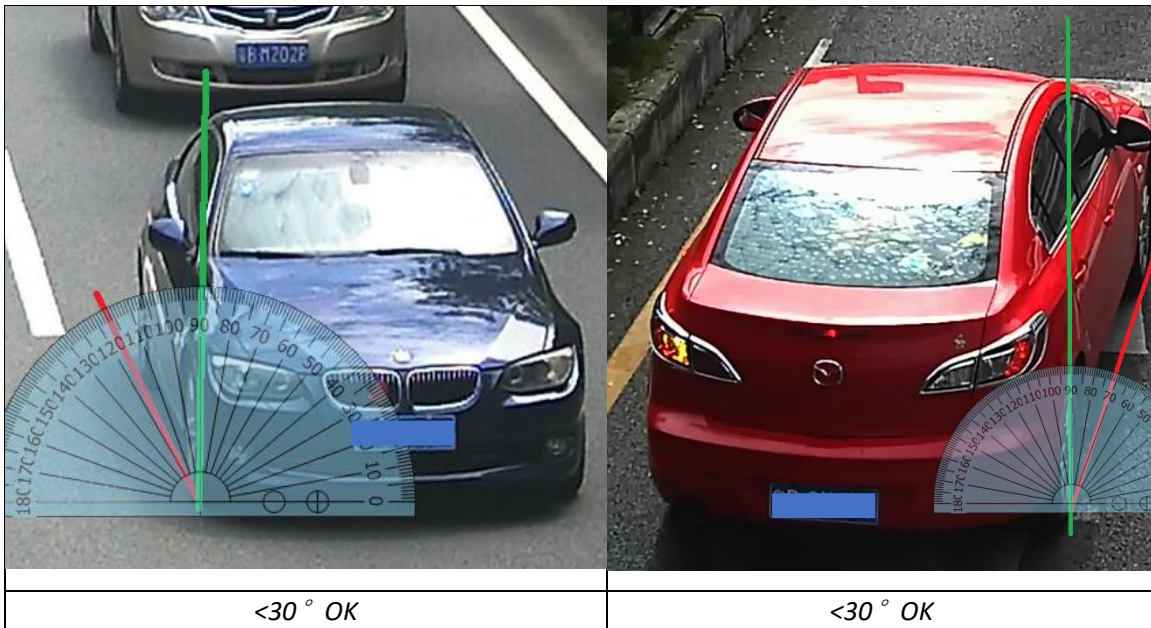
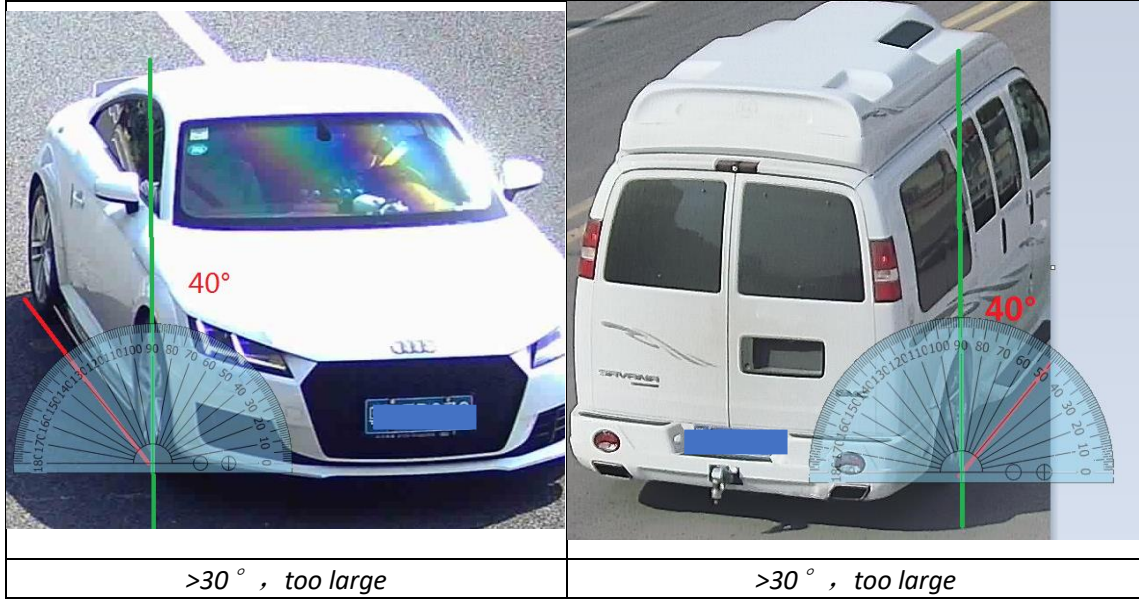

(6) The pixels of following objects need to satisfy:

	Plate Characters Recognition	Vehicle Logo Recognition	Vehicle Type Recognition(*)
2 MP Camera	20<Height<30 100<Width<200	>25 x 25	>256

4 MP Camera	27<Height<40 135<Width<270	>34 x 34	>345
-------------	-------------------------------	----------	------

***Note:** For vehicle type recognition, the camera needs to be installed at a bayonet and be able to overview the whole vehicle. The short edge of vehicles's circumscribed rectangle (see illustration fig. below) should be larger than the pixels listed on above table.



Chapter 2 Configurations

- (1) Go to Image>Display Settings>Day/Night Switch and set the Day/Night Switch to the "Triggered by Video";

^ Day/Night Switch

Day/Night Switch	Triggered by Video
Sensitivity	4
Filtering Time	<input type="range" value="5"/>
Smart Supplement Light	OFF
Supplement Light Mode	IRlight Supplement Light
Light Brightness Control	Auto

(2) Go to Image>Display Settings to change Exposure Time and Gain according to the standard below (the Gain control can be operated only after step 1 is finished):

Speed < 30km/h — Exposure Time : **1/150-1/200**;

30km/h < Speed < 60km/h — Exposure Time : **1/250-1/500**;

60km/h < Speed — Exposure Time : **1/500-1/1000**

Gain : Generally set as **20** and we usually don't change this.

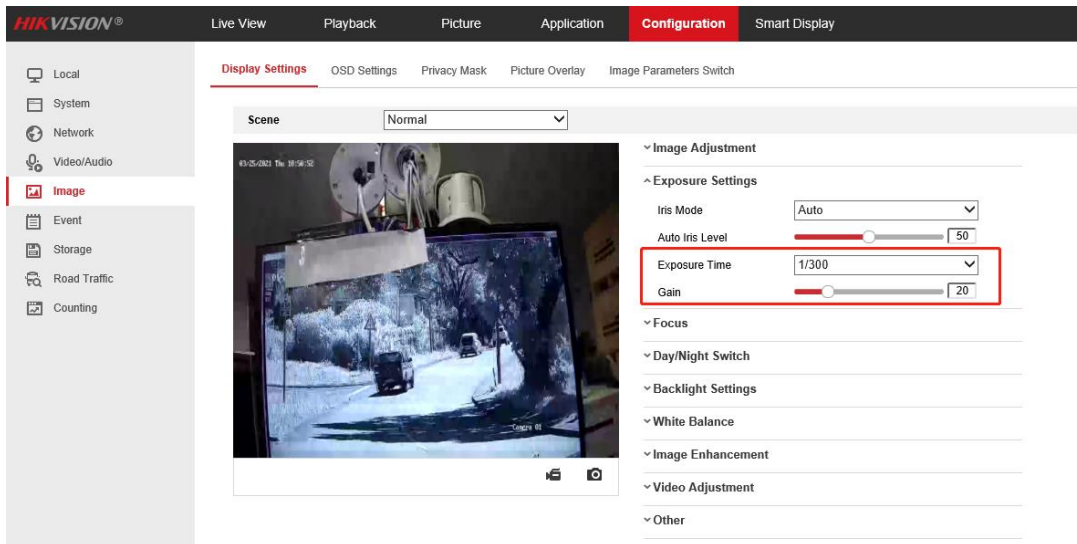

(3) Make sure the Focus Mode is semi-auto.

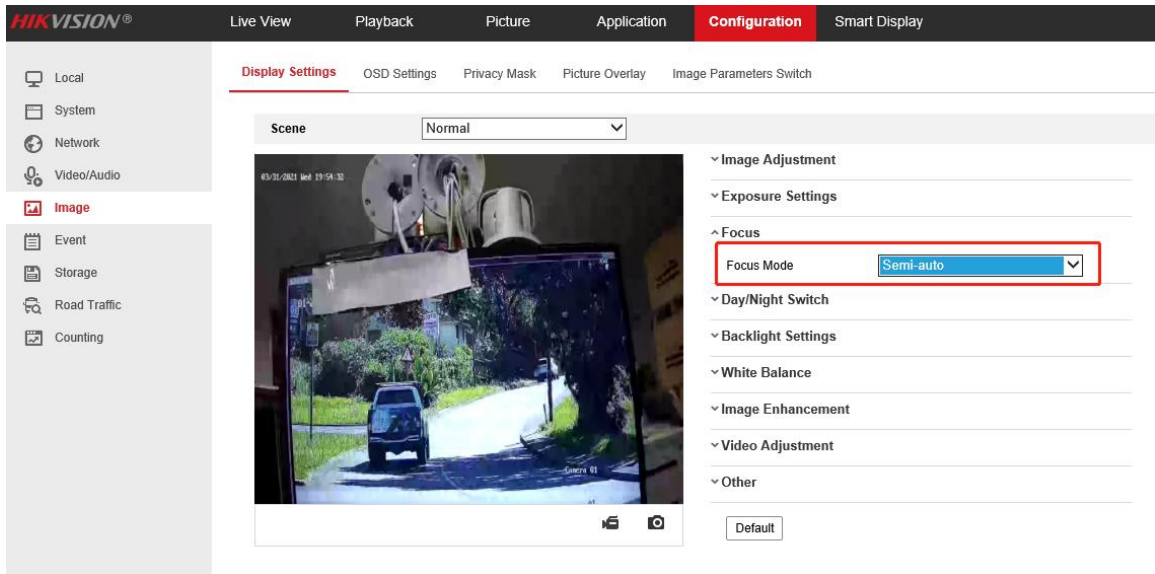

If the image effect is not satisfied:

- a. Choose the pre-settings Scene and the referring using scenario to try whether the effect is getting better.

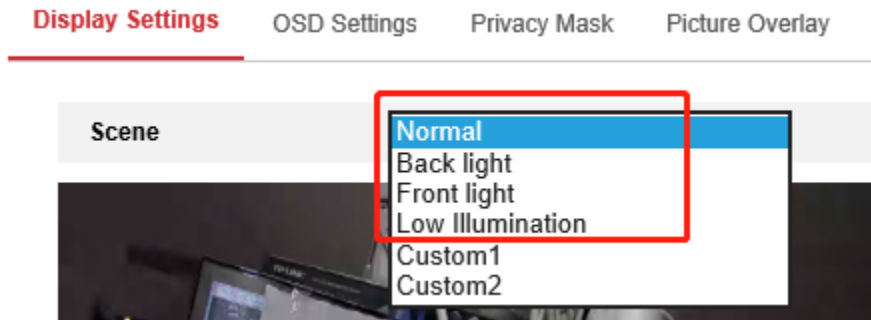

- b. WDR or HLC will make the image easier to perform the “ghost image” or detail lost. So if the strong light can be solved by the exposure and gain settings, we don’t recommend you enable these to counter strong lights.

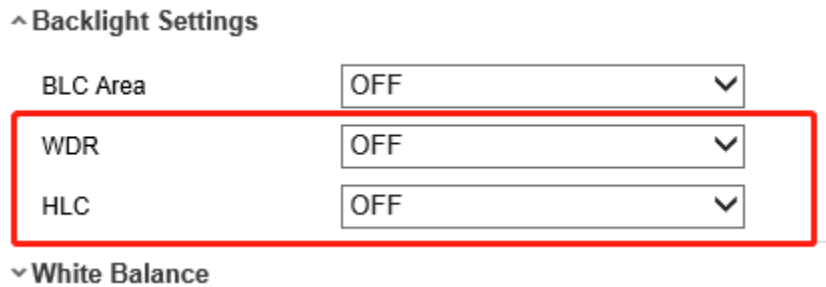

- c. Double check whether the installation angle is smaller than 30° and the

installation height satisfy the full observation of full scale of vehicle.

(4) Go to Picture to choose the text overlay on the picture as the scenario needs;

The screenshot shows the Hikvision VCA configuration interface. The top navigation bar includes 'Live View', 'Playback', 'Picture', 'Application', 'Configuration', 'Smart Display', and 'VCA'. The left sidebar shows 'VCA Resource', 'General VCA Settings', and 'Road Traffic' (highlighted). The main panel is titled 'Picture' and contains the following settings:

- Picture Type:** Background, license plate/target close-up, Vehicle
- Picture Quality:** (Slider set to 80)
- Picture Size:** (Slider set to 1024 kb)
- Overlay:**
 - Font Color: [Color Picker]
 - Background Color: [Color Picker]
- Text Overlay:**
 - Device No. Capture Time Vehicle Type Moving Direction Plate No. Camera Info.
 - Validity Vehicle Color Vehicle Brand

Type	Sorting
Camera Info.	↑ ↓
Device No.	↑ ↓
Capture Time	↑ ↓
Plate No.	↑ ↓
Vehicle Color	↑ ↓
Vehicle Type	↑ ↓
Vehicle Brand	↑ ↓
Moving Direction	↑ ↓

©2021 Hikvision Digital Technology Co., Ltd. All Rights Reserved.

(5) Go to Road Traffic to select detection type;

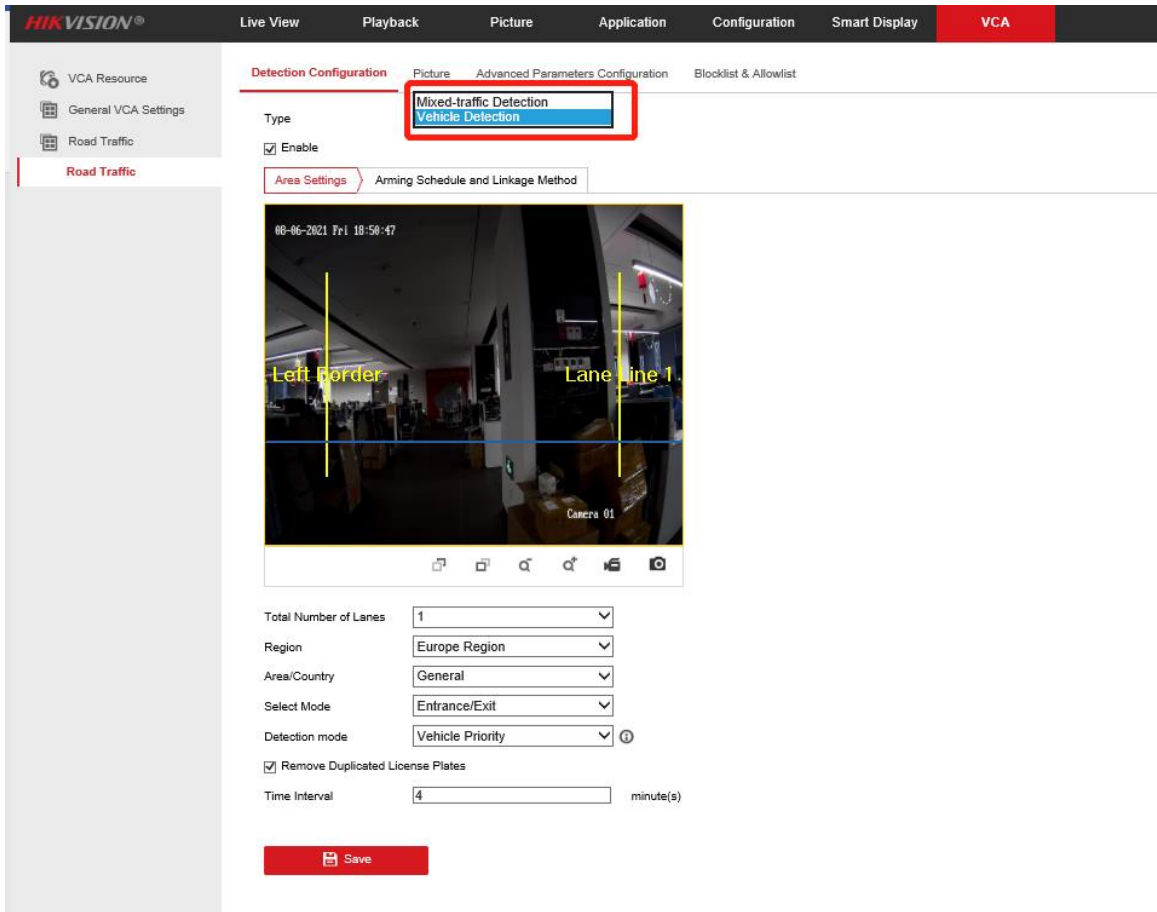

Detection type can be set as Vehicle detection or Mixed-traffic Detection.

- **Vehicle detection:** the passed vehicle can be detected and the picture of its license plate can be captured.
- **Mixed-traffic Detection:** motor vehicle and non-motor vehicle can be detected, and the picture of the object or license plate can be captured

(6) Go to Road Traffic to select lane numbers (1~2) and traffic mode;

The screenshot displays the HIKVISION VCA configuration interface. The top navigation bar includes 'Live View', 'Playback', 'Picture', 'Application', 'Configuration', 'Smart Display', and 'VCA'. The left sidebar shows 'VCA Resource', 'General VCA Settings', and 'Road Traffic'. The main content area is titled 'Detection Configuration' and includes sub-tabs for 'Picture', 'Advanced Parameters Configuration', and 'Blocklist & Allowlist'. The 'Area Settings' tab is active, showing a live camera feed with yellow vertical lines labeled 'Left Border' and 'Lane Line 1', and a blue horizontal line. Below the live view, the following settings are visible:

- Type: Vehicle Detection
- Enable:
- Area Settings: Arming Schedule and Linkage Method
- Total Number of Lanes: 1
- Region: Europe Region
- Area/Country: General
- Select Mode: City Street
- Detection mode: Vehicle Priority
- Remove Duplicated License Plates:
- Time Interval: 4 minute(s)

A red 'Save' button is located at the bottom of the configuration area.

(7) Area Settings:

Blue Detection Line: Mainly used for Entrance/Exit with a purpose of improving the capture efficiency. The line is the trigger line of license plate and we highly recommend you put it middle-lower of the screen to make sure the car can pass it with the plate and the full scale.

Detecting Area: The Actual detect area is the 2 yellow lane and the square they seized.

(8) Select Mode:

Entrance/Exit: It means the camera is set to monitor the Entrance & Exit and will get a better performance at this scenario. Also, E&E mode only supports 1 lane.

City Street: It means the license plate information of the detected vehicle will

be uploaded when the vehicle passes the detection area and triggers the detection. City Street can support 2 lanes.

Alarm Input: It means the input alarm will trigger a license plate capture and recognition action.

(9) Detection Mode:

Vehicle priority mode: the classic mode of the ANPR camera, it will detect the vehicle scale first, then catch the plate out to make the analysis. It will get the better accuracy but sometimes it will lose some results in the not-satisfied installation scenario. When choosing this mode, the City Street mode is recommended.

License plate or Vehicle mode: this mode will allow the ANPR camera to capture the vehicle plate simultaneously with the scale of vehicle is detected. This mode will greatly improve the recognition at some not-satisfied installation scenario. When choosing this mode, the Entrance/Exit mode is recommended.

*So we recommend you to use **Vehicle priority mode first** if there is no issues on installation and filling lights. After the issues of plate recognition is carried out, you can **switch the mode to License plate & Vehicle mode.***

(10) Go to Arming Schedule and Linkage Method to continue:

Here you can set the arming schedule and linkage action independently for allow list, block list and other list, so you need to set them one by one;

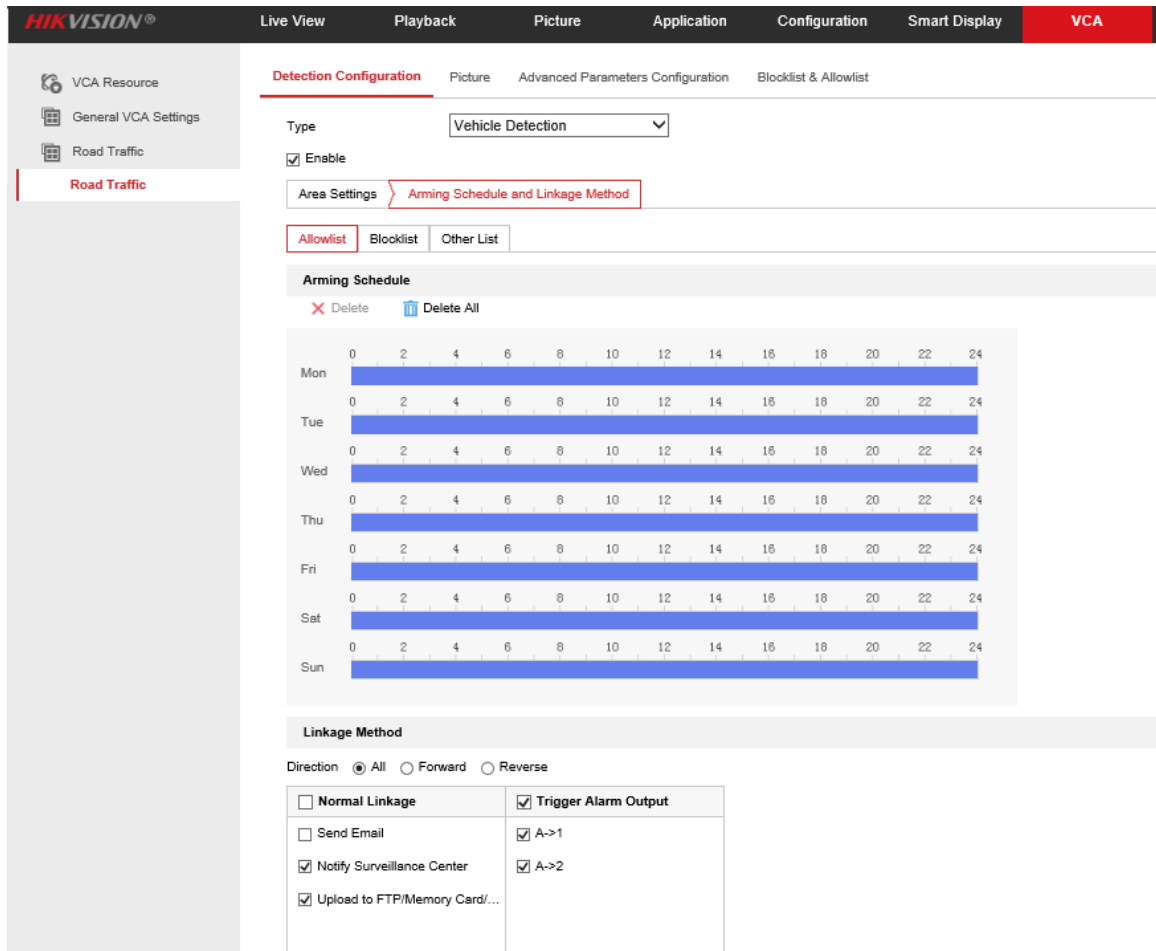

(11) Select a direction here. The Forward means vehicle moves toward the camera; Reverse means vehicle moves away from the camera. Only the vehicles moving as the selected direction can trigger selected linkage methods. We highly recommend you choose All if there is no special use;

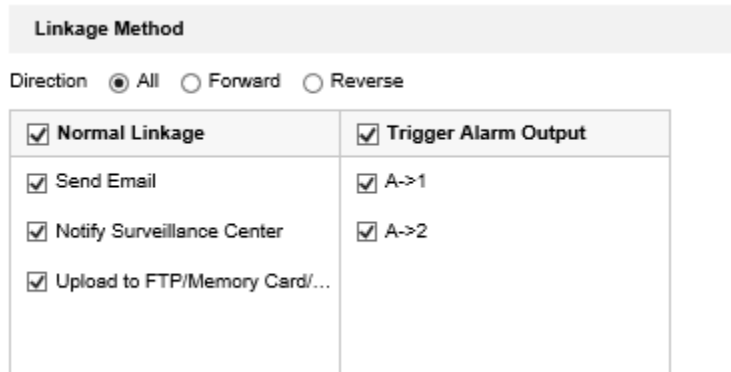

(12) You can set linkage here, including Send Email, Notify Surveillance Center or Upload to FTP/xxxx;

Linkage Method

Direction All Forward Reverse

<input checked="" type="checkbox"/> Normal Linkage	<input checked="" type="checkbox"/> Trigger Alarm Output
<input checked="" type="checkbox"/> Send Email	<input checked="" type="checkbox"/> A->1
<input checked="" type="checkbox"/> Notify Surveillance Center	<input checked="" type="checkbox"/> A->2
<input checked="" type="checkbox"/> Upload to FTP/Memory Card/...	

(13) The last part is to import the blocklist and allowlist. If you don't have such a list in advance, export the template first to make one;

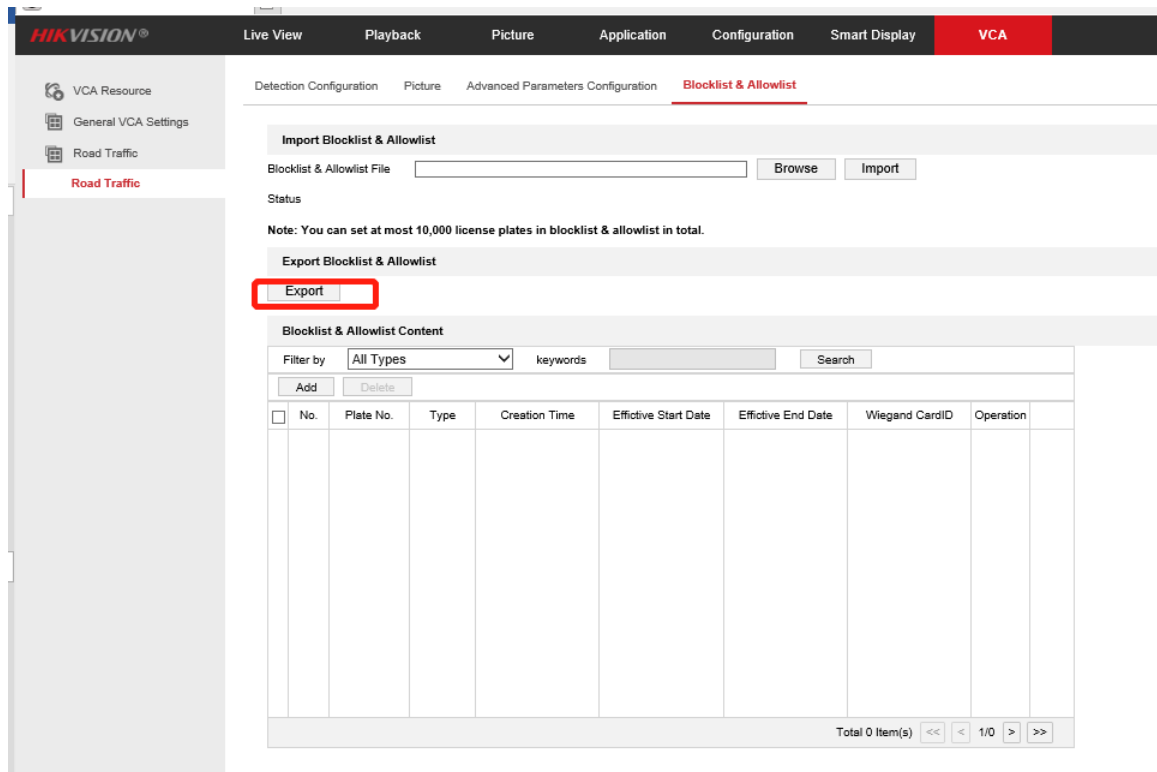

The template looks like this:

(when inputting the plate number, input several consecutive numbers/letters with no blank included.)

The screenshot shows an Excel spreadsheet with the following columns: No., Plate No., Group(0 block list, 1 allow list), Effective Start Date (Format: YYYY-MM-DD, e.g., 2017-12-07), Effective End Date (Format: YYYY-MM-DD, e.g., 2017-12-07), and Card No. The spreadsheet is currently empty.

No.	Plate No.	Group(0 block list, 1 allow list)	Effective Start Date (Format: YYYY-MM-DD, e.g., 2017-12-07)	Effective End Date (Format: YYYY-MM-DD, e.g., 2017-12-07)	Card No.

- (14) After the configuration is done, when there are vehicles passing, you can check the real-time plate recognition results on [Smart Display] on the camera's web page.

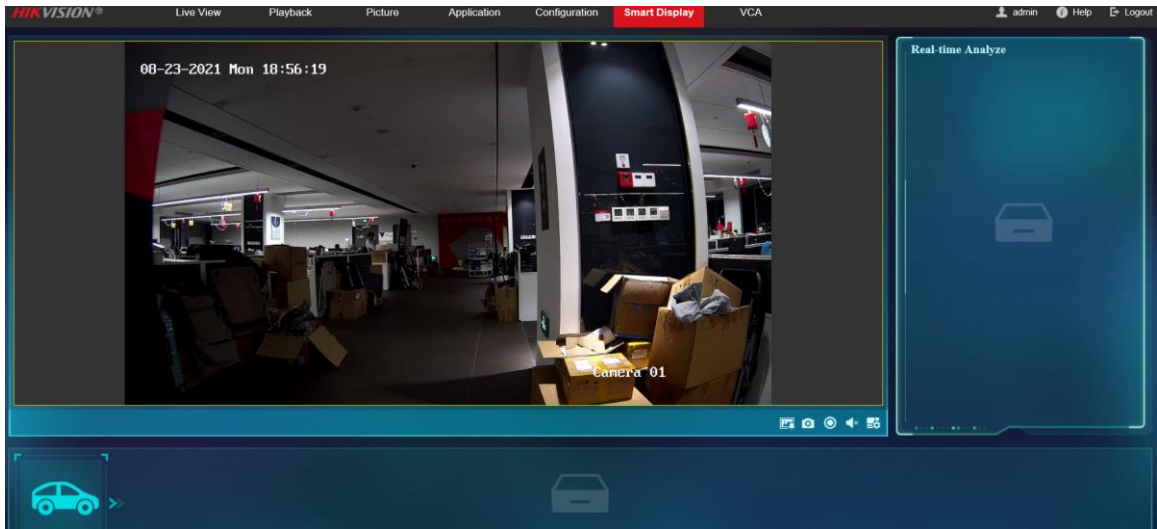

Chapter 3 Operation for Alarm Output

1. Introduction

In many application scenarios, the ANPR camera needs to be linked with device such as barrier or siren. When camera detects an alarm and outputs a I/O signal to control other device. For example, if the license plate is compared successfully, linked barrier opens. Camera Alarm out only applicable to the I/O signal trigger Alarm output device.

2. Hardware Connection

1) Alarm Output Interface Appearance:

H8 ANPR Camera has two Alarm output interfaces: 1A1B and 2A2B.

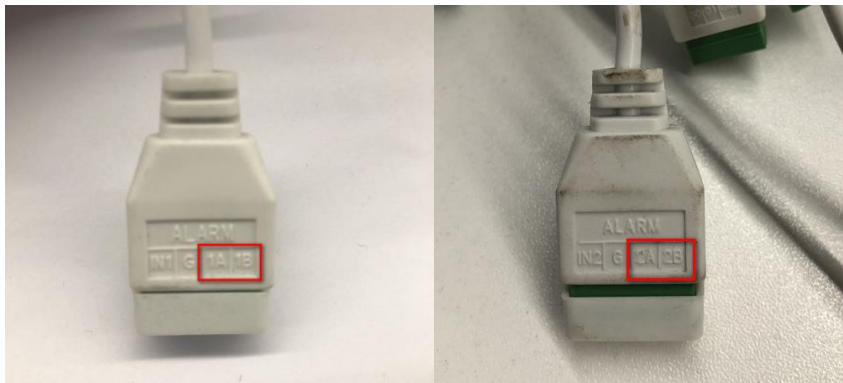

2) Connection:

Note: Camera Alarm output only applicable to the I/O signal triggered devices. Alarm output device needs to be powered by an external power adapter. The camera alarm output is equal to a switch. When the camera does not output an alarm signal, it is in an open circuit state, when the camera outputs an alarm signal, the circuit is closed, alarm device can be triggered.

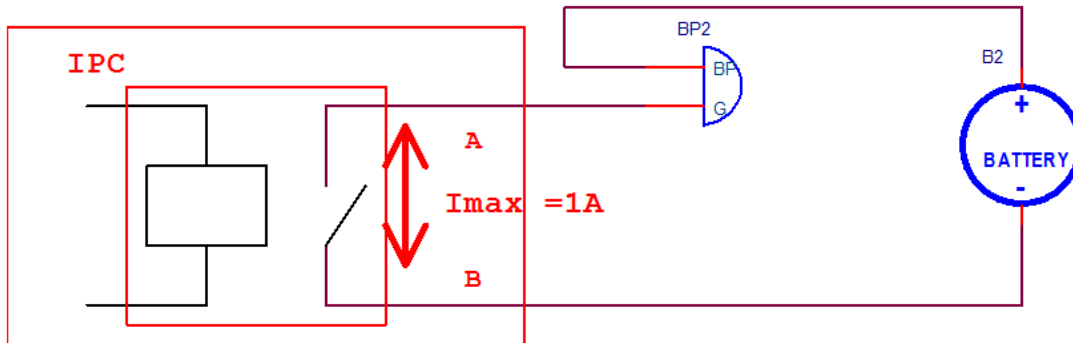

Here we take Hikvision barrier as an example.

Connect method:

Barrier	There are two interfaces to control barrier: Open & COM or Rising Control+ & Rising Control-	
Camera	There are two cables of camera connecting to barrier. The 1A /2A port connects to barrier's Open or Rising Control+ port. The 1B/2B port connects to barrier's COM or Rising Control - port.	

3. Configuration

If the device has been connected to an alarm output device, and the alarm output No. has been configured, the device sends alarm information to the connected alarm output device when an alarm is triggered.

1) Vehicle Detection Configuration

Steps:

- a) Go to **VCA->Road Traffic->Detection Configuration**.
- b) Check the checkbox of **Enable** to enable Vehicle Detection.
- c) Set the specific detection parameters, which are the same as those of conventional ANPR cameras.

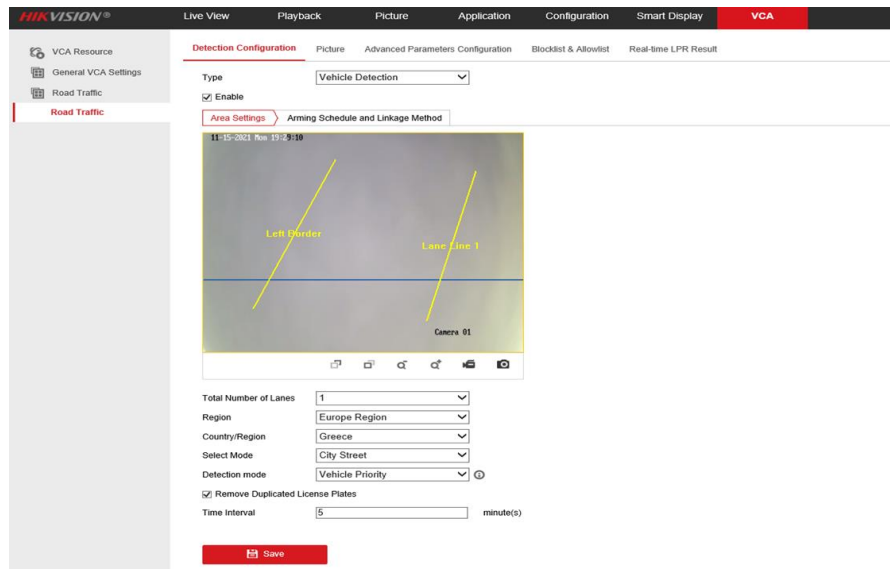

2) Arming Schedule and Linkage Method

Steps:

- a) Go to **VCA->Road Traffic->Detection Configuration->Arming Schedule and Linkage Method**, set the arming schedule for Allowlist, Blocklist or Other List.

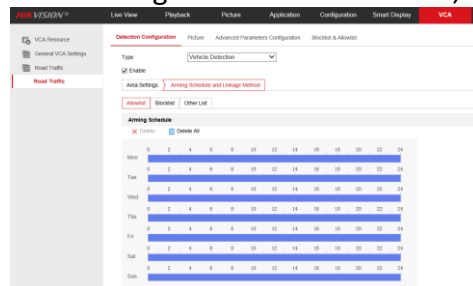

- b) Set the Linkage Method, select trigger alarm output.

Linkage Method

Direction All Forward Reverse

<input type="checkbox"/> Normal Linkage <input type="checkbox"/> Send Email <input checked="" type="checkbox"/> Notify Surveillance Center <input type="checkbox"/> Upload to FTP/Memory Card/...	<input type="checkbox"/> Trigger Alarm Output <input checked="" type="checkbox"/> A->1 <input type="checkbox"/> A->2
---	---

c) Go to Configuration-> **Event>Basic Event>Alarm Output.**

The screenshot shows the 'Alarm Output' configuration page in the Hikvision web interface. The 'Alarm Output No.' is set to 'A-1', 'IP Address' is 'Local', 'Delay' is '5s', and 'Alarm Status' is 'OFF'. Below these settings is a calendar for scheduling the alarm output. The calendar shows a blue bar for each day of the week (Monday to Sunday), indicating that the alarm output is active throughout the week. At the bottom of the page, there are buttons for 'Manual Alarm', 'Copy to...', and 'Save'.

Chapter 4 Operation for Wiegand

1. Introduction

Currently overseas license plate cameras support 4 Wiegand protocols: Card ID 26-bit Wiegand protocol, Hik 34-bit Wiegand protocol, NEWG 72bit Wiegand protocol and SHA-1 26-bit Wiegand protocol. The various protocols are explained as follows.

1) Available Models

The available models of network cameras are:

iDS-2CD7A26G0/P-IZHSY (C)

iDS-2CD7A46G0/P-IZHSY (C)

2) Wiegand Interface Appearance

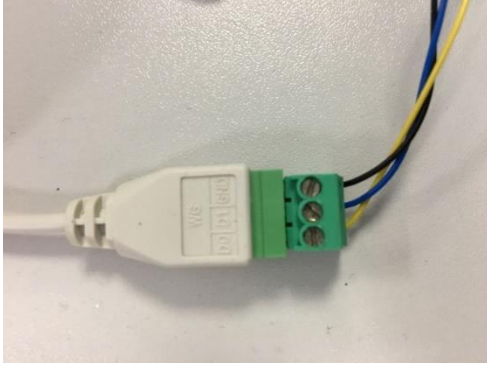

3) Connection

Connect the block's D0, D1 and GND to those of receiving terminal accordingly. The transmission distance is up to 15 meters.

2. Transfer Plate Number via Wiegand Protocol

➤ Card ID 26-bit

1) Protocol Standard

Map the license plate number with the access control card number.

Find the related card number in allowlist and blacklist, and transfer the card information (26 bit) via Wiegand interface.

Determine whether the car has permission to pass according to the card ID.

Compatible with any standard access control system which supports standard Wiegand 26-bit protocol.

Card No. Encoding Mode:

1. The ID number should have 8 digits in total. The first 5 digits are Card ID, the last 3 digits are Site Code.
2. The value range for Card ID are: 0-65535, the value range for Site Code are 0-255.
3. If you enter a number more than 8 digits, the last 8 digits will be kept. For example, if you enter 98984 2118, the effective number will be 89842 118.
4. If you enter a number less than 8 digits, 0 will be added before the number until it is a 8-digit number. For example, 984 2119 will be saved as 09842 119.

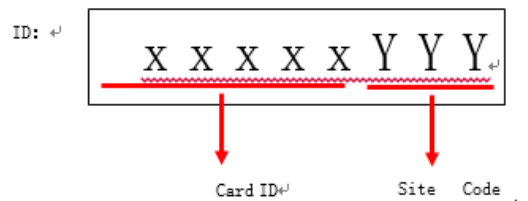

Format Description:

The 26-bit Wiegand format contains 2 parity bits and 24 data bits.

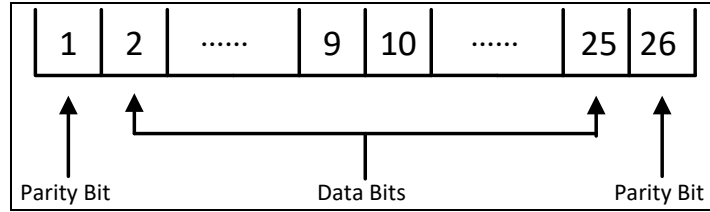

- Bit 1 is an even parity bit for the first 12 bits (bit 2 to bit 13).
- Bit 26 is an odd parity bit for the last 12 bits (bit 14 to bit 25).
- Bit 2 to bit 9 is site code in binary format, if the site code ID is less than 8 digits, 0 will be added before the ID until it is 8-digit number.
- Bit 10 to bit 25 is site code in binary format, if the card ID is less than 8 digits, 0 will be added before the ID until it is 16-digit number.

Example:

Here we take card number: 12345 011 as example.

The coding process are show as below.

Steps:

Split the card number as the **card ID (12345)** and site code (011).

1. Convert 12345 to binary format, as: 0011000000111001.
2. Convert 011 to binary format, as: 00001011.
3. Site data and card data as: 0000 1011 **0011 0000 0011 1001**.
4. Bit 1 is an even parity bit for the first 12 bits (bit 2 to bit 13), as 1.
5. Bit 26 is an odd parity bit for the last 12 bits (bit 14 to bit 25), as 1.
6. According to the converting mode(Even parity bit + site data + card data + odd parity bit), you can get a binary code as: **1** 00001011 0011000000111001 **1**.

2) Configuration

1. Set Wiegand Type as Card ID 26bit

Steps:

Go to **Configuration-> System Settings->Wiegand** to enable wiegand transfer and select protocol type.

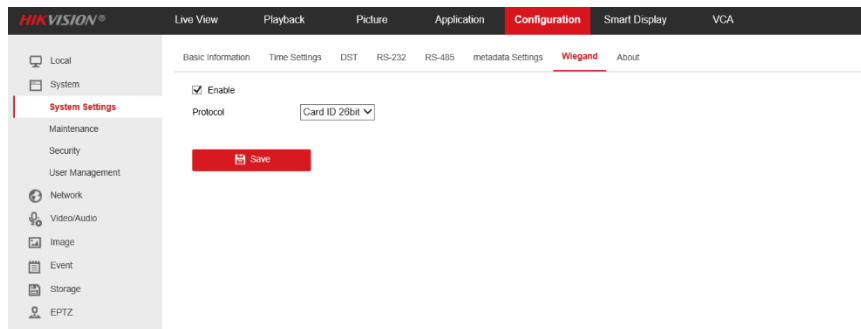

2. Vehicle Detection Configuration

Steps:

- 1) Go to **VCA->Road Traffic->Detection Configuration.**
- 2) Check the checkbox of **Enable** to enable Vehicle Detection.
- 3) Set the specific detection parameters, which are the same as those of conventional ANPR cameras.

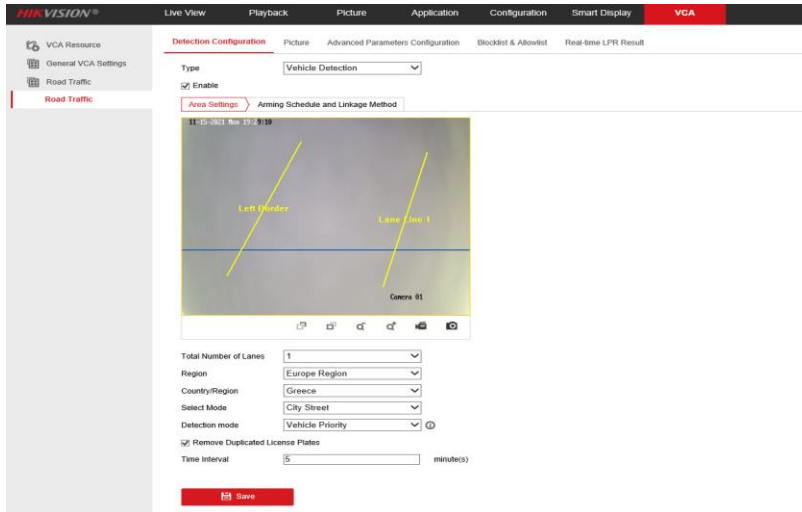

3. Configure Blocklist & Allowlist

Steps:

- 1) Go to **VCA->Road Traffic->Blocklist & Allowlist.**
- 2) Click **Export** to download Blocklist & Allowlist template.
- 3) Fill in the template.

No.	A	B	C	D	E
1	No.	Plate No.	Group(0 Blocklist, 1 Allowlist)	Expiry Date (Format: YYYY-MM-DD, e.g., 2017-12-07)	Card No.
2	1	AD537MX	0	2020-12-12	12345671
3	2	AG377PR	0	2020-12-12	12345672
4	3	AG985MC	1	2020-12-12	12345673
5	4	AW055HC	1	2020-12-12	912345674
6	5	AD319DV	1	2020-12-12	1234567
7					

Note:

When importing the plates' list.

- The Card No. is required, and cannot larger than 8 digits.
- 10000 license plates are supported in allowlist and blocklist in total.
- Make sure there are no repeated plate number and/or Card No. in the list.

➤ **Hik 34bit**

1) Protocol Standard

Map the license plate number with the access control card number.

Find the related card number in allowlist and blocklist, and transfer the card information

(34 bit) via Wiegand interface.

Determine whether the car has permission to pass according to the card number.

The protocol for directly transferring the access control card No. through the Wiegand interface is a private protocol of Hikvision, compatible with Hikvision access control system.

Card No. Encoding Mode:

Support up to 10-digit card number. If you enter a card number of more than 10 digits, only the first 10 digits are kept. Currently, the maximum supported card number is 2147483647.

Format Description:

The 34-bit Wiegand format contains 2 parity bits and 32 data bits.

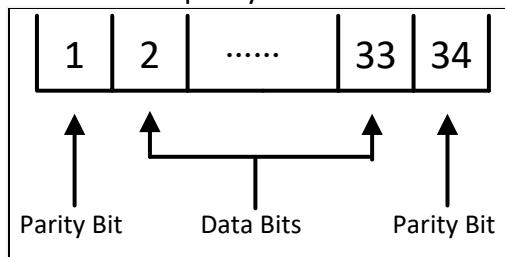

- The return result (even parity bit + card data + odd parity bit) will be sent to Hikvision access control device supporting Wiegand protocol.
- The front parity bit is the even parity bit of the first 16 bits of the card number.
- The rear parity bit is the odd parity bit of the last 16 bits of the card number.

Example:

Take Card number:1234567890

The coding process are show as below.

1. Convert 1234567890 to hexadecimal format, as: 0x49 0x96 0x02 0xD2.
2. Convert 0x49 0x96 0x02 0xD2 to binary format, as: 0100 1001 1001 0110 0000 0010 1101 0010.
3. Bit 1 is an even parity bit for the first 16 bits (bit 2 to bit 17), as **1**.
4. Bit 34 is an odd parity bit for the last 16 bits (bit 18 to bit 33), as **0**.
5. According to the converting mode(even parity bit + card data + odd parity bit), you can get a binary code as: **1** 0100 1001 1001 0110 0000 0010 1101 0010 **0**

2) Configuration

1. Set Wiegand Type as Hik 34bit

Steps:

Go to **Configuration-> System Settings->Wiegand** to enable wiegand transfer and select protocol type.

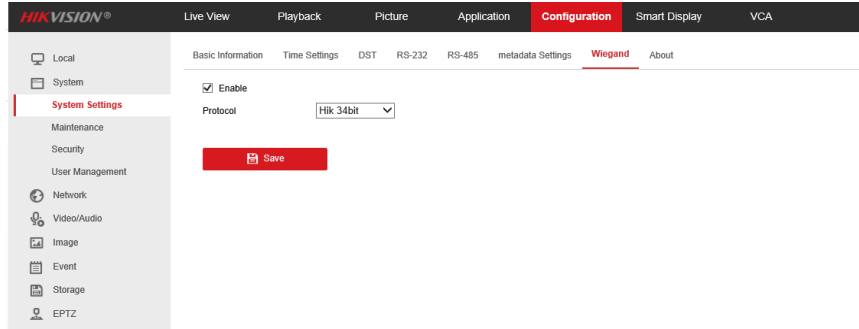

2. For the steps to enable Vehicle Detection and Blocklist & Allowlist Configuration, please see Chapter 2 Configurations.

Note:

When importing the plates' list.

- The Card No. is required, and cannot larger than 10 digits.
- 10000 license plates are supported in allowlist and blocklist in total.
- Make sure there are no repeated plate number and/or Card No. in the list.

➤ **SHA-1 26bit**

1) Protocol Standard

The Wiegand interface directly transmits the license plate number, and performs a hash operation on the license plate number.

The 24 bits are taken through the Wiegand standard interface, and an even parity bit and an odd parity bit are added before and after the 24 bits respectively according to the standard 26 bit protocol. The result will be sent to Wiegand access control (third parties like Paxton or Salto) equipment.

Compatible directly with access control system and platform of Paxton in the UK and Salto in Europe.

Card No. Encoding Mode:

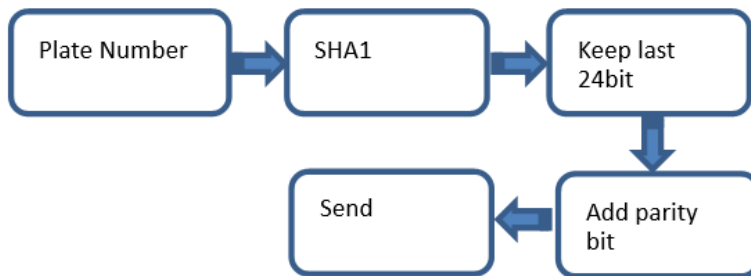

Example:

Here we take the license plate number HK55EVB as example. The coding steps are shown as follows.

Steps:

1. Convert HK55EVB by SHA1 mode is: 0x80cf15.

2. Output a 8-bit binary code for each set of number via the Wiegand interface: 1000 0000 1100 1111 0001 0101
3. Bit 1 is an even parity bit for the first 12 bits (bit 2 to bit 13), as 1.
4. Bit 26 is an odd parity bit for the last 12 bits (bit 14 to bit 25), as 0.

Results:

You can get a binary code as 1 1000 0000 1100 1111 0001 0101 0.

2) Configuration

1. Set Wiegand Type as SHA-1 26bit

Steps:

Go to **Configuration-> System Settings->Wiegand** to enable wiegand transfer and select protocol type.

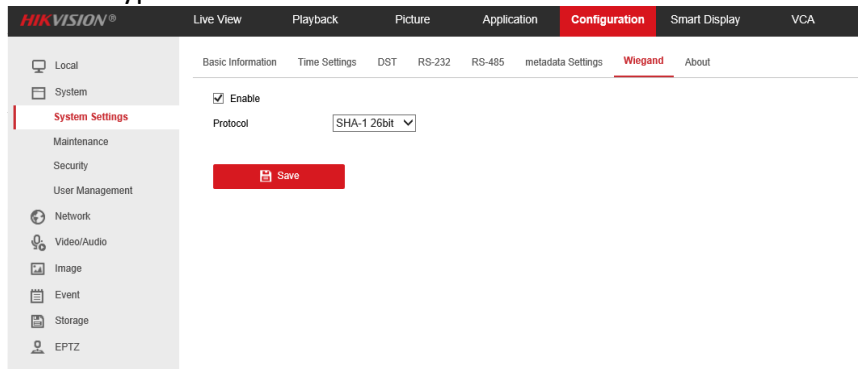

2. For the steps to enable Vehicle Detection, please see Chapter 2 Configurations. Blocklist & Allowlist Configuration is not required.

➤ **NEWG 72bit**

1) Protocol Standard

The 72-bit Wiegand format contains 72 data bits and no parity bit. 72 data bits represents for the license plate number information.

Example:

Here we take the license plate number 2180807 as example. The coding steps are as follows.

Steps:

1. Convert 2180807 to a ASSIC code: 0x32 0x31 0x38 0x30 0x38 0x37 0x30.
2. Add another 2 bytes in the end of the ASSIC code: 0x32 0x31 0x38 0x30 0x38 0x37 0x30 0x00 0x00.
3. Output a binary code of the ASSIC code via the Wiegand interface.

Results:

You can get a binary code as shown in below.

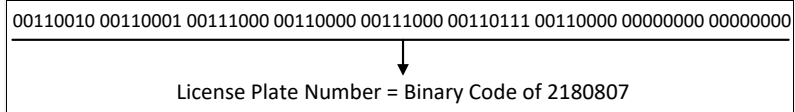

Note:

NEWG 72bit Wiegand protocol does not support transfer license plate number with non-English characters.

2) Configuration

- a. Set Wiegand Type as NEWG 72bit

Steps:

Go to **Configuration-> System Settings->Wiegand** to enable wiegand transfer and select protocol type.

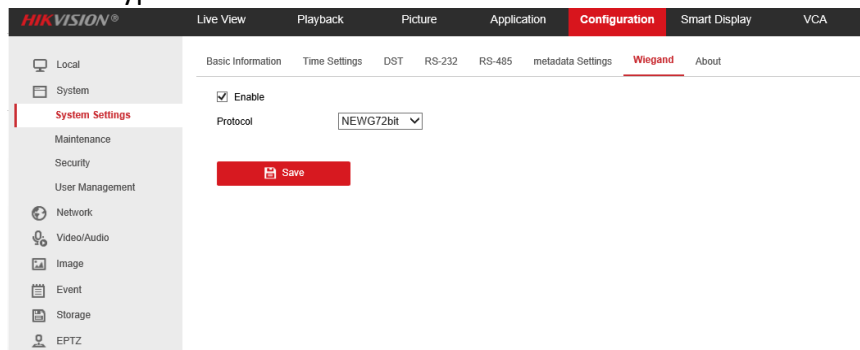

- b. For the steps to enable Vehicle Detection, please see Chapter 2 Configurations. Blocklist & Allowlist Configuration is not required.

3. Testing Method

➤ Software

Collect camera SSH log to check if the license plate is successfully recognized and sent through Wiegand.

Steps:

- 1. Go to **Configuration-> System->Security->Security Service** to enable SSH.

- 1) Connect camera to Hikvision access control controller wiegand interface.

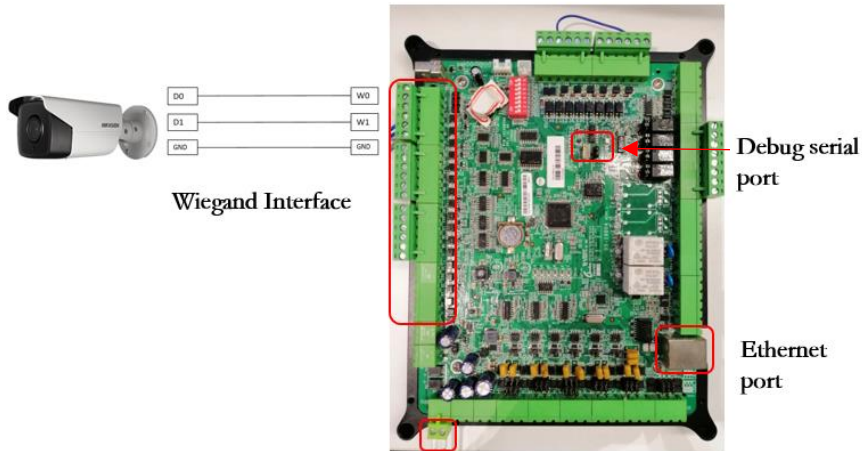

- 2) Connect 4 pin RS232/RJ45 convertor board to Access Controller debug port and computer USB port.



- 3) Power on Access Controller.
- 4) Access device via SecureCRT software, input the print information that we need:
weigenDebugOn
- 5) Login camera web page select the wiegand protocol you need. If it is CardID 26bit or HIK 34bit protocol, please configure Blocklist & Allowlist in advance.
- 6) Check Access Controller log.