

DS-2DE4A425IWG-E 4 MP 25 × Network IR PTZ Camera

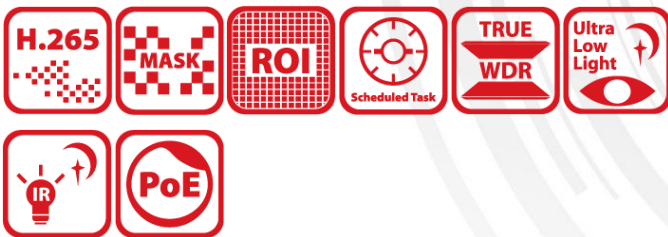

Hikvision DS-2DE4A425IWG-E 4 MP Network IR PTZ Camera adopts 1/2.8" progressive scan CMOS chip. With the 25 × optical zoom lens, the camera offers more details over expansive areas. This series of cameras can be widely used for wide ranges of high-definition, such as the rivers, forests, roads, railways, airports, ports, squares, parks, scenic spots, stations and large venues, etc.

- High quality imaging with 4 MP resolution, up to 30 fps
- Excellent low-light performance via powered-by-DarkFighter technology
- Clear imaging against strong back lighting due to 120 dB WDR technology
- Pan and tilt ability enables camera to monitor zones of interest
- 25 × optical zoom allows for closer viewing of subjects in expansive areas
- Up to 50 m IR range ensures safety at night
- Water and dust resistant (IP66)
- Focuses on human and vehicle targets classification based on deep learning

▪ DORI

The DORI (detect, observe, recognize, identify) distance gives the general idea of the camera ability to distinguish persons or objects within its field of view.

It is calculated based on the camera sensor specification and the criteria given by EN 62676-4: 2015.

| DORI | Detect | Observe | Recognize | Identify |
|-----------------|--------------------|-------------------|-------------------|------------------|
| Definition | 25 px/m | 63 px/m | 125 px/m | 250 px/m |
| Distance (Tele) | 2200 m (7217.8 ft) | 873 m (2864.2 ft) | 440 m (1443.6 ft) | 220 m (721.8 ft) |

▪ Specification

| Camera | |
|------------------------|---|
| Image Sensor | 1/2.8" Progressive Scan CMOS |
| Max. Resolution | 2560 × 1440 |
| Min. Illumination | Color: 0.005 Lux @ (F1.6, AGC ON), B/W: 0.001 Lux @ (F1.6, AGC ON), 0 Lux with IR |
| Shutter Speed | 1/1 s to 1/30,000 s |
| Day & Night | IR cut filter |
| Zoom | 25 × optical, 16 × digital |
| Slow Shutter | Yes |
| Lens | |
| Focal Length | 4.8 to 120 mm |
| FOV | Horizontal FOV 53.3° to 2.6°, vertical FOV 30.6° to 1.5°, diagonal FOV 60.5° to 3° |
| Focus | Auto, semi-auto, manual |
| Aperture | Max. F1.6 |
| Zoom Speed | Approx. 3.4 s |
| Illuminator | |
| Supplement Light Type | IR |
| Supplement Light Range | IR Distance: up to 50 m |
| Smart Supplement Light | Yes |
| IR Wavelength | 850 nm |
| PTZ | |
| Movement Range (Pan) | 0° to 360° |
| Movement Range (Tilt) | -5° to 90° |
| Pan Speed | Pan speed: configurable from 0.1° to 300°/s; preset speed: 350°/s |
| Tilt Speed | Tilt speed: configurable from 0.1° to 160°/s, preset speed 200°/s |
| Proportional Zoom | Yes |
| Presets | 300 |
| Preset Freezing | Yes |
| Patrol Scan | 8 patrols, up to 32 presets for each patrol |
| Pattern Scan | 4 pattern scans, record time over 10 minutes for each scan |
| Park Action | Preset, pattern scan, patrol scan, auto scan, tilt scan, random scan, frame scan, panorama scan |
| 3D Positioning | Yes |
| PTZ Status Display | Yes |
| Scheduled Task | preset, pattern scan, patrol scan, auto scan, tilt scan, random scan, frame scan, panorama scan, dome reboot, dome adjust |

| | |
|-----------------------------|---|
| Power-off Memory | Yes |
| Video | |
| Main Stream | 50 Hz: 25 fps (2560 × 1440, 1920 × 1080, 1280 × 960, 1280 × 720) 60 Hz: 30 fps (2560 × 1440, 1920 × 1080, 1280 × 960, 1280 × 720) |
| Sub-Stream | 50 Hz: 25 fps (704 × 576, 640 × 480, 352 × 288); 60 Hz: 30 fps (704 × 480, 640 × 480, 352 × 240) |
| Third Stream | 50 Hz: 25 fps (1920 × 1080, 1280 × 960, 1280 × 720, 704 × 576, 640 × 480, 352 × 288); 60 Hz: 30 fps (1920 × 1080, 1280 × 960, 1280 × 720, 704 × 480, 640 × 480, 352 × 240) |
| Video Compression | Main stream: H.265+/H.265/H.264+/H.264 Sub-stream: H.265/H.264/MJPEG Third stream: H.265/H.264/MJPEG |
| H.264 Type | Baseline Profile/Main Profile/High Profile |
| H.265 Type | Main profile |
| Scalable Video Coding (SVC) | H.264 and H.265 encoding |
| Region of Interest (ROI) | 8 fixed regions for each stream |
| Audio | |
| Audio Compression | G.711alaw/G.711ulaw/G.722.1/G.726/MP2L2/PCM/AAC-LC |
| Audio Bit rate | 64 Kbps (G.711)/16 Kbps (G.722.1)/16 Kbps (G.726)/32 to 192 Kbps (MP2L2)/ 128 to 1024 Kbps (PCM)/16 to 64 Kbps (AAC-LC) |
| Audio Sampling Rate | AAC-LC: 16 kHz, 32 kHz, 48 kHz; MP2L2: 16 kHz, 32 kHz, 48 kHz; PCM: 8 kHz, 16 kHz, 32 kHz, 64 kHz |
| Environment Noise Filtering | Yes |
| Network | |
| Protocols | IPv4/IPv6, HTTP, HTTPS, 802.1x, Qos, FTP, SMTP, UPnP, SNMP, DNS, DDNS, NTP, RTSP, RTCP, RTP, TCP/IP, UDP, IGMP, ICMP, DHCP, PPPoE, Bonjour, WebSocket, WebSockets |
| Simultaneous Live View | Up to 20 channels |
| API | Open Network Video Interface (Version 18.12), Profile S, Profile G, Profile T), ISAPI, SDK, ISUP |
| User/Host | Up to 32 users; 3 user levels: administrator, operator, and user |
| Security | Password protection, complicated password, HTTPS encryption, 802.1X authentication (EAP-TLS, EAP-LEAP, EAP-MD5), watermark, IP address filter, basic and digest authentication for HTTP/HTTPS, control timeout settings, security audit log, TLS 1.2, host authentication (MAC address) |
| Network Storage | NAS (NFS, SMB/CIFS), auto network replenishment (ANR) |
| Client | iVMS-4200, HikCentral Pro, Hik-Connect |
| Web Browser | IE 10 to 11, Chrome 57+, Firefox 52+, Safari 11+ |
| Image | |
| Image Parameters Switch | Yes |
| Image Settings | Saturation, brightness, contrast, sharpness, gain, and white balance adjustable by client software or web browser |
| Day/Night Switch | Day, Night, Auto, Schedule |
| Wide Dynamic Range (WDR) | 120 dB |
| SNR | > 52 dB |
| Defog | Digital Defog |
| Image Enhancement | BLC, HLC, 3D DNR |

| | |
|-------------------------------|--|
| Privacy Mask | 24 programmable polygon privacy masks, mask color or mosaic configurable |
| Regional Focus | Yes |
| Regional Exposure | Yes |
| Interface | |
| Ethernet Interface | 1 RJ45 10 M/100 M self-adaptive Ethernet port |
| On-board Storage | Built-in memory card slot, support microSD/SDHC/SDXC card, up to 256 GB |
| Audio | 1 input (line in), max. input amplitude: 2-2.4 vpp, input impedance: 1 K Ω \pm 10%; 1 output (line out), line level, output impedance: 600 Ω |
| Alarm | 2 inputs, 2 outputs |
| Reset | Yes |
| Event | |
| Basic Event | Motion detection, video tampering alarm, exception, alarm input and output |
| Smart Event | line crossing detection, intrusion detection, region entrance detection, region exiting detection, unattended baggage detection, object removal detection, audio exception detection |
| Alarm Linkage | Upload to FTP/NAS/memory card, notify surveillance center, send email, trigger alarm output, trigger recording, and PTZ actions (such as preset, patrol scan, pattern scan) |
| Smart Tracking | Manual tracking, auto-tracking |
| Deep Learning Function | |
| Face Capture | Detects up to 5 faces simultaneously, Supports detecting, tracking, capturing, grading, selecting of face in motion, and outputs the best face picture |
| General | |
| Power | 12 VDC, Max. 24 W; PoE (802.3at) |
| Dimension | \varnothing 169 mm \times 161 mm (\varnothing 6.65" \times 6.34") |
| Weight | Approx. 2.45 kg (5.40 lb.) |
| Operating Condition | -30 $^{\circ}$ C to 65 $^{\circ}$ C (-22 $^{\circ}$ F to 149 $^{\circ}$ F). Humidity 90% or less (non-condensing) |
| General Function | Mirror, password protection |
| Approval | |
| Protection | IP66 (IEC 60529-2013), TVS 6000V lightning protection, surge protection and voltage transient protection |

▪ Available Model





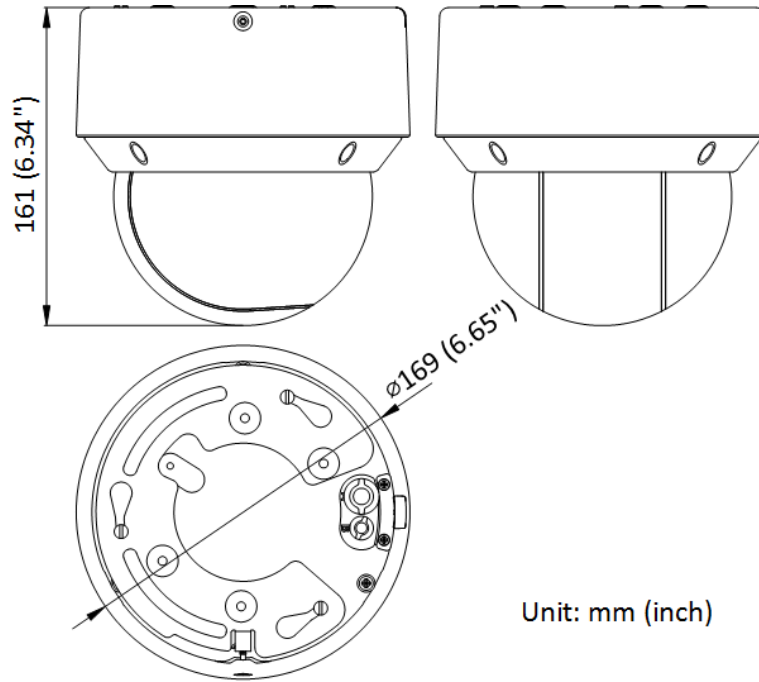

DS-2DE4A425IWG-E

▪ Dimension



▪ **Accessory**

▪ **Optional**

| DS-1691ZJ-M Pendant Mount | DS-1691ZJ Pendant Mount | DS-1605ZJ Wall Mount | DS-1691ZJ-L Pendant Mount | DS-1280ZJ-SD11 Junction Box |
|---|---|---|---|---|
|  |  |  |  |  |
| <p>DS-1671ZJ-SD11 In-Ceiling Mount</p>  | | | | |

Headquarters

No.555 Qianmo Road, Binjiang District,
Hangzhou 310051, China
T +86-571-8807-5998
www.hikvision.com



Follow us on social media to get the latest product and solution information.

